

# Smooth Drive™

## ORDINARY DEVICES

Shadow created by fixed bracket legs



## SMOOTH DRIVE

Walking diffuser eliminates leg shadow



Ordinary rotating sprinklers have stationary legs that block water and create leg shadows. The Smooth Drive's walking diffuser eliminates bracket leg shadows resulting in unobstructed, uniform distribution.

Senninger's Smooth Drive is designed for under-tree, open-field and nursery irrigation. Its unique "walking diffuser" helps deliver an extremely uniform pattern that prevents dry areas caused by distortion from bracket legs.

## FEATURES

- Low Angle model ideal for under-tree (white base)
- High Angle model ideal for open-field (black base)
- Precision-contoured deflector provides greater throw and enhanced distribution
- Advanced braking mechanism for smooth, consistent rotation speed and minimal riser stress
- No tools required for accessing nozzle
- Flow rates: 1.34 to 2.79 gpm (304 to 634 L/hr)
- Operating pressures: 25 to 40 psi (1.72 to 2.76 bar)
- Connections: ½" NPT male  
½" socket x ¾" socket x 1" spigot  
20 mm socket x 25 mm socket
- Solvent-weld base for theft resistance
- Two-year warranty on materials, workmanship and performance
- Color-coded nozzles for easy size identification. Warranted to maintain correct orifice size for five years



## TWO MODELS

LA model (White)



HA model (Black)



See Inlet connection options in features



NON-IMPACT

SPRINKLER BASE PRESSURE-US	psi				SPRINKLER BASE PRESSURE-METRIC	bar			
	25	30	35	40		1.72	2.07	2.41	2.76
<b>#6 Nozzle - Gold (3/32")</b>					<b>#6 Nozzle - Gold (2.38 mm)</b>				
Flow (gpm)	-	1.34	1.45	1.55	Flow (L/hr)	-	304	329	352
LA Diameter at 1.5 ft ht (ft)	-	65	67	68	LA Diameter at 0.46 m ht (m)	-	19.8	20.4	20.7
HA Diameter at 1.5 ft ht (ft)	-	68	70	72	HA Diameter at 0.46 m ht (m)	-	20.7	21.3	21.9
<b>#7 Nozzle - Lime (7/64")</b>					<b>#7 Nozzle - Lime (2.78 mm)</b>				
Flow (gpm)	1.68	1.84	1.99	2.12	Flow (L/hr)	382	418	452	482
LA Diameter at 1.5 ft ht (ft)	63	67	68	69	LA Diameter at 0.46 m ht (m)	19.2	20.4	20.7	21.0
HA Diameter at 1.5 ft ht (ft)	67	72	74	77	HA Diameter at 0.46 m ht (m)	20.4	21.9	22.6	23.8
<b>#8 Nozzle - Lavender (1/8")</b>					<b>#8 Nozzle - Lavender (3.18 mm)</b>				
Flow (gpm)	2.21	2.42	2.62	2.79	Flow (L/hr)	502	550	595	634
LA Diameter at 1.5 ft ht (ft)	65	68	69	71	LA Diameter at 0.46 m ht (m)	19.8	20.7	21.0	21.6
HA Diameter at 1.5 ft ht (ft)	70	74	77	78	HA Diameter at 0.46 m ht (m)	21.3	22.6	23.5	23.8

Sprinkler performance may vary with actual field conditions. Minimum recommended height is 1.5 ft (0.46 m).





















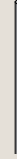

# Riser Adapter Assemblies

Senninger Riser Adapter Assemblies make irrigating easier in hard to reach places and is ideal for temporary and portable systems. They are connected to the laterals allowing the sprinklers on each to be repositioned as needed.





## FEATURES



- ▶ No gluing or fusing required
- ▶ Suitable for sprinkler or spray nozzles with a 1/2" NPT male base connection
- ▶ Components available for 0.345" and 0.270" PE tubing
- ▶ Riser adapter suitable for the 14" or 26" Riser Stakes as well as 1/2" PVC, 3/4" PVC, or 5/16" steel rod

COMPONENTS

LOWER FLOWS (Use with 0.270" tubing)		HIGHER FLOWS (Use with 0.345" tubing)			
RSASM2TC3QCA	RSASM23C3	RSASM24C3QCA2T	RSASM24C3QCA3T	RSASM24C3	RSASM24C4
<b>RSAD2T</b> (QUICKCONNECT) 1/2" F x #2 Taper 	<b>RSAD270</b> 1/2" F x 0.270" Tubing 	<b>RSAD345</b> 1/2" F x 0.345" Tubing 	<b>RSAD345</b> 1/2" F x 0.345" Tubing 	<b>RSAD345</b> 1/2" F x 0.345" Tubing 	<b>RSAD345</b> 1/2" F x 0.345" Tubing 
<b>FTA1B2T</b> 0.270" Super Barb x #2 Taper 					
<b>TU1ST3</b> 3 ft (0.9 m) 0.270" I.D. 	<b>TU1ST3</b> 3 ft (0.9 m) 0.270" I.D. 	<b>TU15ST3</b> 3 ft (0.9 m) 0.345" I.D. 	<b>TU15ST3</b> 3 ft (0.9 m) 0.345" I.D. 	<b>TU15ST3</b> 3 ft (0.9 m) 0.345" I.D. 	<b>TU15ST4</b> 4 ft (1.2 m) 0.345" I.D. 
<b>FTA1B2T</b> 0.270" Super Barb x #2 Taper* 	<b>FTA1B1B</b> 0.270" Super Barb x Hose Barb Insert Adapter 	<b>FTA15B2T</b> 0.345" Super Barb x #2 Taper* 	<b>FTA15B3T</b> 0.345" Super Barb x #3 Taper** 	<b>FTA15B15B</b> 0.345" Super Barb x Hose Barb Insert Adapter 	<b>FTA15B15B</b> 0.345" Super Barb x Hose Barb Insert Adapter 
<b>FTHS2T</b> Winged Hose Barb Bushing #2 Taper 		<b>FTHS2T</b> Winged Hose Barb Bushing #2 Taper 	<b>FTHS3T</b> Winged Hose Barb Bushing #3 Taper 		

Friction loss through the entire assembly: - including 3 ft (0.9 m) of 0.270" ID PE tubing - is 6.3 psi at 2.0 gpm (0.43 bar at 454 L/hr) - including 3 ft (0.9 m) of 0.345" ID PE tubing - is 1.7 psi at 2.0 gpm (0.117 bar at 454 L/hr).  
Contact technical support for friction loss on flows greater than 2 gpm (454 L/hr) or tubing lengths greater than 3 ft (0.9 m).

#2 TAPER		#3 TAPER	
<b>FT4HSC2T</b> Barb Bushing Clamp for 1" Hose #2 Taper* 	<b>FT1M2T</b> Winged 1/4" M NPT Threaded Bushing #2 Taper* 	<b>FTPLUG2T</b> #2 Taper* (Red) 	<b>FTPLUG3T</b> #3 Taper** (Maroon) 

GREEN PUNCH	RED PUNCH
<b>TUPTAP4I</b> - for use w/ FTA1B1B 	<b>TUPTAP5I</b> - for use w/ FTA15B15B, FTHS2T, FTHS3T, FT1M2T, FT4HSC2T 

RSST26	RSST14
<b>Riser Stake 26"</b> Connection for Riser Adapter or barbed base micro-sprinkler into tubing (0.25", 0.270", or 8mm) 	<b>Riser Stake 14"</b> Connection for Riser Adapter or barbed base micro-sprinkler into tubing (0.25", 0.270", or 8mm) 